

# Introduction

## Introduction

---

### About the SBC LI970

Most remote control systems have to be operated by pointing the remote control directly towards a device. Any obstacle between the remote control and the device disturbs the operating signal. But what if you like to place your devices inside a closed cabinet, a closet or even in another room?

The SBC LI970 provides the solution to overcome obstacles like furniture or walls. Your devices no longer have to be placed in line of sight but can be operated from virtually any location. The SBC LI970 is a RF Extender that is used in combination with the ProntoPro Remote Control. The RF Extender receives **radio frequency** (RF) signals sent out by the ProntoPro and converts them into **infrared** (IR) signals. These IR signals are then sent out to your TV, DVD, preamplifier and so on.

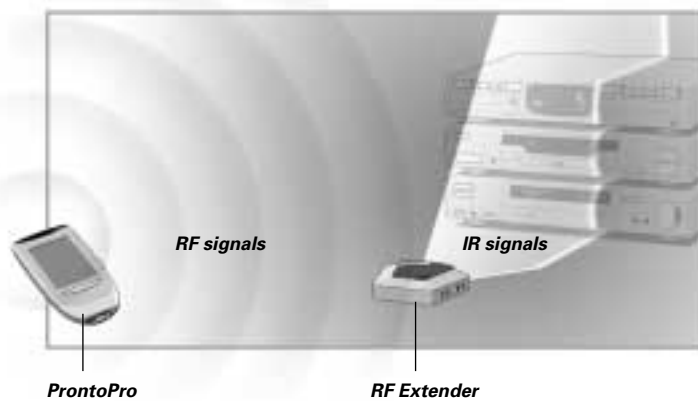

## Introduction

### Possible Set-ups

The RF Extender can be used in several situations:

- Your devices can be remotely controlled while the RF Extender is placed in line of sight (situation A).
- The RF Extender controls devices placed in an adjacent room (situation B).
- The RF Extender is placed inside a closet, a rack or another piece of furniture together with your devices (situation C).
- The set-ups in situation A, B and C can be combined. If you want to control devices in different locations, you have to place a RF Extender in each location. You can control all RF Extenders with the same ProntoPro Remote Control. See Multiple RF Extenders on p. 6 to apply the necessary settings.

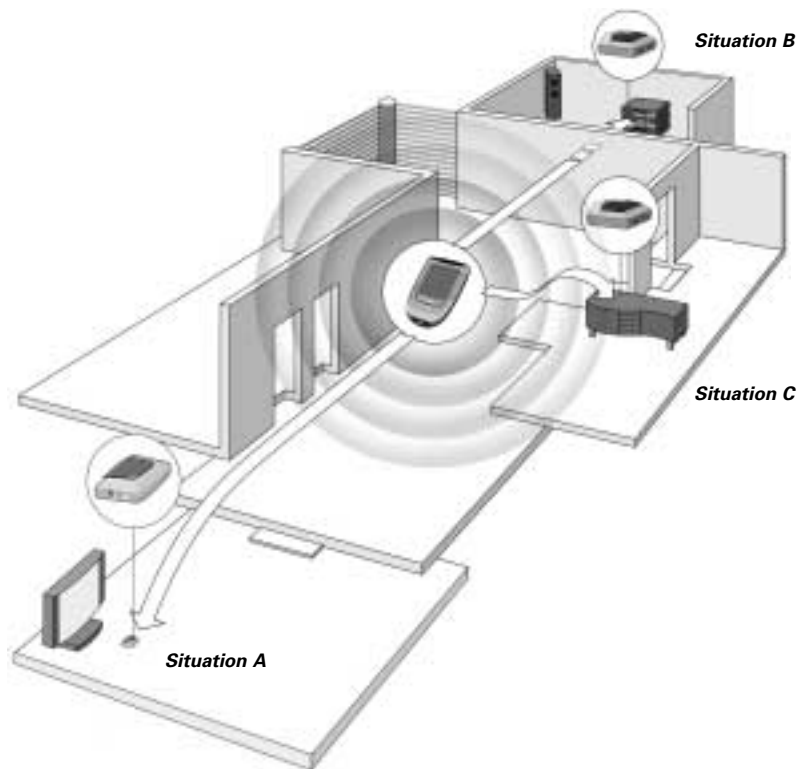

# Installation

## Installation

The following components should be present: RF Extender, power adapter, 4 dual IR emitters, mounting plate and 4 screws.

Before you install the RF Extender, you should decide which of the set-ups described on p. 2 apply to your needs. It is recommended to read through the entire User Manual.

### Working Angle and Range of the IR blaster

*Warning* The IR signals sent out by the RF Extender always have to be able to reach the receiving eyes of your devices. Make sure that the IR blaster (dark plastic window on top of the RF Extender) is aimed at your devices.

To get optimal results, it is recommended to place the RF Extender horizontally with the IR blaster facing up or down.

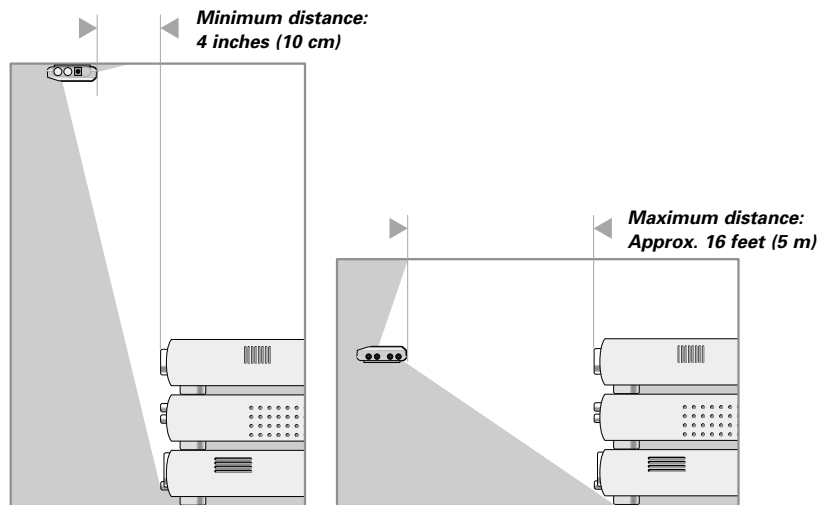

**Figure 1: IR blaster facing down**

**Figure 2: IR blaster facing up**

**Figure 1** represents the RF Extender mounted up side down inside a closet. Always maintain a minimum distance of 4 inches (10 cm) between the RF Extender and your devices.

**Figure 2** represents the RF Extender with the IR blaster facing up. The RF Extender can be placed at a distance and higher than your devices. Make sure there are no objects between the RF Extender and the receiving eyes of the devices.

## Installation

### Mounting

The RF Extender can be mounted to a piece of furniture using the included mounting plate and the 4 screws. Take into account the range and the working angle of the IR blaster as explained on p. 3. Also make sure to place the RF Extender in a **central position** aimed directly at your devices.

*Warning* It is advised not to place the RF Extender inside or near a **metal** closet as RF signals can be disturbed by metal objects.

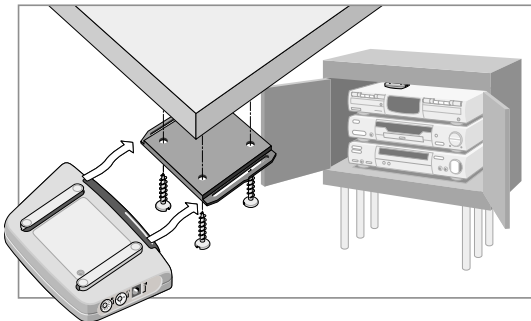

- 1 Remove the mounting plate from the bottom of the RF Extender.
- 2 Screw the plate to a rack, closet or another piece of furniture. Provide sufficient space to connect the power adapter and to slide the RF Extender back on.

*Note* Depending on the surface, it may be possible to attach the RF Extender to the furniture using a piece of 2-sided tape. Look for the right position and make sure there is sufficient space.

- 3 Slide the RF Extender on the mounting plate.

### Using the Dual IR Emitters

Like the IR blaster of the RF Extender, the **dual IR emitters** send out IR signals. You can use the dual IR emitters as an **alternative** for the IR blaster.

#### **When to use the emitters**

The IR emitters can control devices the IR blaster cannot reach, for instance when there is limited space around the receiving eyes of the devices, e.g. in a small closet.

*Note* The IR emitters can also be used in **combination** with the IR blaster of the RF Extender. Both send out IR signals simultaneously. This allows you to operate several devices using both the IR blaster and the IR emitters.

## Installation

### How to use the emitters

The dual IR emitters can be attached to the surrounding surface facing the receiving eyes or directly to the receiving eyes.

- 1 Attach the emitters to a surface above, below or in front of the receiving eyes of your devices (for aesthetic appearance or when it is difficult to locate the receiving eye).  
– or –  
Attach the emitters directly to the receiving eyes of your devices.

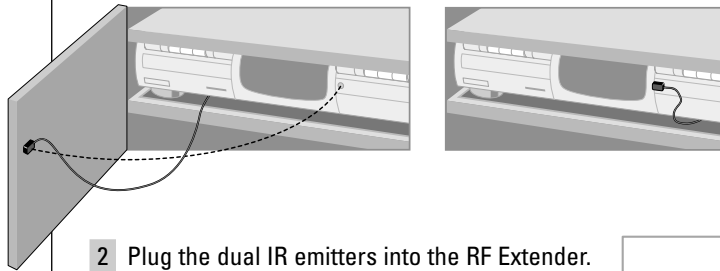
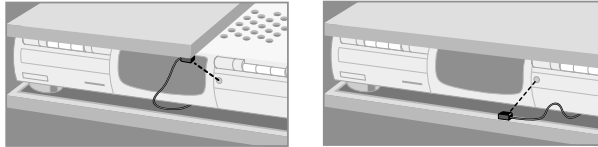

- 2 Plug the dual IR emitters into the RF Extender.

*Note* To avoid interference, the wires of the emitters should be kept away from the RF Extender as far as possible.

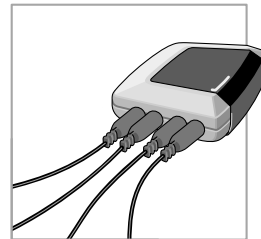

### Connecting the Power Adapter

When connecting the power adapter it is recommended that you plug the adapter into the RF Extender before you plug it into the socket. When connected you will see a red LED on the RF Extender.



*Note* To avoid interference, the adapter cable should be kept away from the RF Extender as far as possible.

## Installation

### Settings

As the RF Extender 'communicates' with the ProntoPro Remote Control, you have to set the same **Extender ID** (identity) on both appliances. The settings depend on whether you have a single RF Extender or multiple RF Extenders.

#### Single RF Extender

When you use only one RF Extender, you can accept the default setting for the Extender ID (ID=0). Make sure your ProntoPro Remote Control is set to the same default setting (see the ProntoPro User Manual for more details).

#### Multiple RF Extenders

If you want to operate several of your devices independently, e.g. grouped on different locations, you will need multiple RF Extenders. When using several RF Extenders, it is important to assign a unique Extender ID to each RF Extender. 16 Extender IDs (from 0 to 9 and from A to F) can be assigned.

- 1 Choose an Extender ID for the RF Extender by turning the ID dial with a small screwdriver.
- 2 On the ProntoPro Remote Control, choose the same Extender ID for each device controlled by the RF Extender.  
Refer to the ProntoPro User Manual for more information.
- 3 Try to operate your devices with the ProntoPro Remote Control.  
The red LED will blink when the RF Extender receives a correct command.
- 4 Repeat this procedure for every RF Extender.

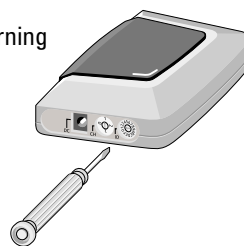

#### RF Interference

If your devices are not responding to commands or if the red LED on the IR blaster is blinking without sending commands, it might be possible that there is RF interference. This can be the case when other RF appliances are operated nearby, for instance at your neighbours.

When you notice RF interference, you have to choose another channel on your RF Extender. 4 channels (CH from 0 to 3) can be assigned.

- 1 Choose a channel for the RF Extender by turning the CH dial with a small screwdriver.
- 2 On the ProntoPro Remote Control, choose the same channel for the devices controlled by the RF Extender.  
Refer to the ProntoPro manual for more information.
- 3 Try to operate your devices with the Remote Control.

# Troubleshooting

## Troubleshooting

---

### ***Devices do not respond properly***

- Check if the power adapter is connected and the red LED is on.
- Check if the ID and channel numbers on the RF Extender match with the ID and channel numbers on the ProntoPro Remote Control (see p. 6). Refer to the ProntoPro User Manual for more details on the settings of the Remote Control.
- Check the placement of the RF Extender:
  - Check the distance between the RF Extender and the ProntoPro Remote Control (see p. 2).
  - Check the range and the working angle of the IR blaster (see p. 3).
  - Check if the RF Extender is placed in a central position relative to your devices (see p. 4).
  - Make sure that the distance between the RF Extender and your device is at least 4 inches (10 cm).
  - Make sure that the distance between the RF Extender and your device is at most 16 feet (5 m).
  - Make sure the IR signals between the RF Extender and the receiving eyes of your devices are not disturbed by any objects.
  - Check if metal objects, for instance a metal closet, wires or cables, surrounding the RF Extender do not disturb the RF signals.
  - If you are using the dual IR emitters, make sure they are connected properly and that they are placed within range of the receiving eyes (see p. 5).
- It might be possible that some commands cannot be sent out as RF signals. In that case you will have to reconfigure the ProntoPro Remote Control to operate your devices with IR signals again.

### ***The red LED on the RF Extender blinks without using the ProntoPro Remote Control***

- This indicates RF interference. Another device in the proximity is sending out RF signals. Change the channel (CH) on the RF Extender (see p. 7).

### ***There is no red LED on my RF Extender***

- Check if the power adapter is connected properly.

### ***The dual IR emitters are no longer adhesive***

- Replace the adhesive with a fresh piece of the 2-sided tape.

### ***I cannot find the exact location of the device's receiving eye***

- Check the manual of the device.  
When still in doubt, contact your supplier or the manufacturer.

# Specifications

## Specifications

The specifications and design of this product are subject to change without notice.

<b>Hardware</b>	<i>Red LED (continuously on when powered, blinking during RF reception) 16 IDs and 4 CHs 4 outputs for IR emitters Possibility to have multiple RF extenders in one home not interfering Positioning: freestanding, mounted horizontally or hanging up side down</i>
<b>Dimensions</b>	<i>4.5 x 3.2 x 1.2 inch (113 x 81 x 30 mm)</i>
<b>Operating temperature</b>	<i>32°F to 122°F (0°C to 50°C)</i>
<b>Infrared (IR)</b>	<i>Operating distance: up to 16 feet (5 meters) IR frequency range: DC/flash codes, 36kHz-550kHz</i>
<b>Radio frequency (RF)</b>	<i>Operating distance: up to 100 feet (30 meters) depending on the surrounding conditions Frequency: 433 MHz (US)</i>
<b>Dual IR emitters</b>	<i>Number of IR emitters: up to 8 (4x2), emitters wired in series 3.5mm mono mini-plug Cable length: 10 feet (2.5 meters) Max. range: 3 feet (75 cm)</i>
<b>Accessories</b>	<i>120V AC Power adapter (400mA/12V DC adapter, UL-approved) Mounting kit (Plate and 4 screws)</i>
<b>Approvals</b>	<i>The device complies with part 15.19(a)(3) of the FCC Rules. Operation is subject to the following two conditions: (1) this device may not cause harmful interference and (2) this device must accept any interference received including interference that may cause undesired operation.</i>  <i>Philips Consumer Electronics Company, Knoxville, Tennessee 37914 – 1810 U.S.A.</i>